

UHF Wireless Microphone System



DESCRIPTION

With the addition of new microphone models compatible with rechargeable batteries, together with battery chargers, a newly launched receiver unit and earphones, the TOA 5000 Series offers a diverse range of applications and high-quality performance levels, plus the additional benefit of lower running costs. TOA 5000 Series microphones that use rechargeable batteries are the handheld vocal microphone WM-5265, and the speech-use WM-5225. Lavalier models YP-M5300, and YP-M5310 are in the line-up, as are the WH-4000H headset model, and the WH-4000A headset for aerobics/active applications, and all of them work with the WM-5325 wireless transmitter, which also is powered by a rechargeable battery. For those who prefer a slim single-battery powered microphone, the WM-5270 is available.

The WM-5325 UHF wireless transmitter is now a standalone unit allowing operation with a range of available microphones. The compact WT-5100 portable receiver, with YP-E5000 ear-suspension earphone, is designed for tour-guide and listening assistance applications. Battery chargers are another new addition to the lineup.

To give microphones a reliable and wide coverage area, all TOA 5000 Series UHF wireless microphone tuners utilize Phase Locked Loop (PLL) synthesis to deliver exceptionally stable performance. TOA true diversity or space diversity circuitry, a usable frequencies scanning channel search function, a double super-heterodyne receiving system, and a squelch function are also included. The tuners are the WT-5800 (true diversity), WT-5805 (space diversity), the WT-5810 basic tuner, and the WT-4820 tuner for optional up to 2 tuner units. The WT-5800 and WT-5805 provide four 16-channel banks of circuit frequencies, and the WT-5810 has 16 selectable frequencies. Extensive and reliable coverage is ensured by the YW-4500 UHF wireless antenna.

FEATURES

Wireless Microphone Units

- Dynamic and (unidirectional/omnidirectional) electret condenser cardioid microphones.
- Up to 16 microphones can be used in the same area without any interference problems.
- A wide operating range allows microphones to be used up to a maximum of 120 meters distance from the antenna units.
- The rechargeable battery delivers 13 hours of continuous use at average temperatures.
- Three types of chargers enable 2-, 6- and 12-battery charging.

Tuner Units

- TOA's proprietary true diversity and space diversity technologies and algorithms for constant area coverage.
- Tone squelch function automatically mutes output when the incoming signal strength goes below a settable signal strength level to prevent annoying noise.

- Microphone sensitivity control allows adjusting the input level to suit the user's voice level and to prevent overloading or distortion.
- Auto mixing input function makes it possible to connect one unit's AF input to the AF output of another unit.
- Indication of microphone's battery status
- A channel check function simplifies channel setting operations on wireless microphones used on multiple channels simultaneously.
- Comander circuitry works to minimize ambient noise.

Ancillary Equipment

- Using WD-4800, a system allowing simultaneous use of up to 16 separate channels can be confirmed.
- The TOA BC-5000-2 is a dedicated battery charger for the WM-5225 and WM-5265 microphones, WM-5325 transmitter, and the WT-5100 portable receiver



WM-5270

Handheld (Vocal) Microphone

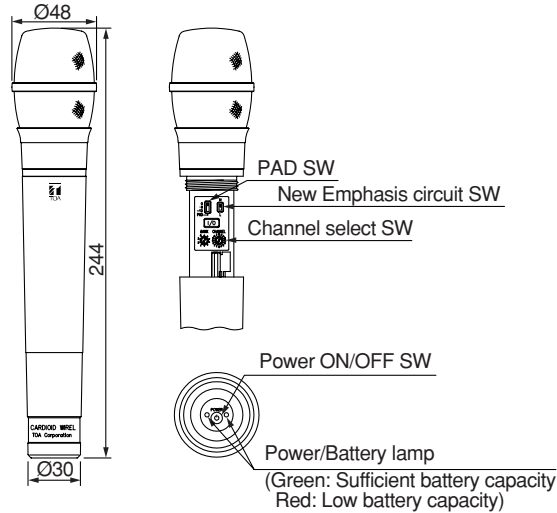

- Unidirectional dynamic cardioid microphone element designed for vocal use
- 64 selectable channels
- Maximum input level: 142 dB SPL (Can be set from 130dB to 142dB by Pad switch)
- Dynamic range: 95 dB or more
- Single AA battery operation for more compact and lightweight body
- Low-battery indicator (Sufficient power/Green, Low battery/Dimming green, Empty/Red)
- Built-in antenna

Microphone Element	Dynamic microphone unit: Omnidirectional
Modulation	Frequency modulation
Frequency Range	576 –865 MHz*, UHF
Channel Selectable	64 channels (the number of channels may differ from country to country.)
RF Carrier Power	50 mW or less
Tone Frequency	32.768 kHz
Oscillator	PLL synthesizer
Maximum Input Level	142 dB SPL
Maximum Deviation	±40 kHz
Audio Frequency Response	80Hz – 15kHz
Dynamic Range (AF Circuit)	95dB or more (with WT-5800)
Battery	AA alkaline dry cell battery
Battery Life	Approx. 10h (when the alkaline battery is used)
Indicator	Power/Battery lamps
Antenna	Built-in type
Operating Temperature	-10°C to +50°C (14°F to 122°F)
Finish	Dark gray
Dimensions	ø48 × 244 mm (ø1.89" × 9.61")
Weight	340g (0.75 lb) (with battery)
Accessory	Microphone holder (with stand adapter) × 1, Screw driver (housed in the body) × 1, Storage case × 1, Rolling stopper × 1

Type	Frequency Range
A01	692 –722 MHz, UHF
B01, B02	722 –752 MHz, UHF
C01 – C07	794 –830 MHz, UHF
D01 – D05	830 –865 MHz, UHF
E01	668 –698 MHz, UHF
F01	636 –666 MHz, UHF
G01, G02	606 –636 MHz, UHF
H01	576 –606 MHz, UHF

WM-5265

Handheld (Vocal) Microphone

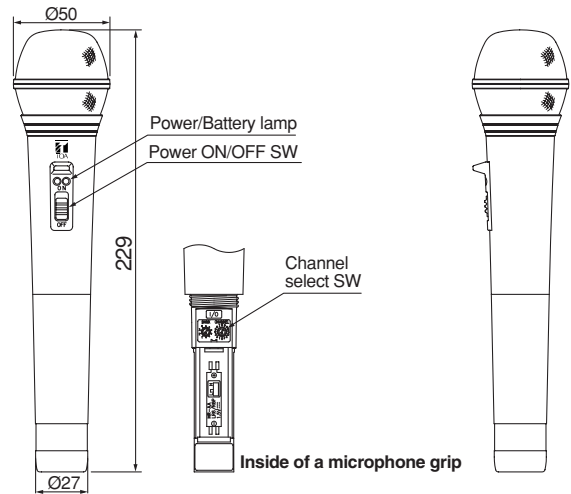

- Unidirectional dynamic cardioid microphone element designed for vocal use
- 64 selectable channels
- Maximum input level: 132 dB SPL
- ON/OFF switch prevents the microphone from rolling
- WB-2000 rechargeable battery or Single AA battery operation for compact and lightweight body
- Low-battery indicator (Sufficient power/Green, Low battery/Dimming green, Empty/Red)
- Built-in antenna

Microphone Element	Dynamic microphone unit: Unidirectional
Modulation	Frequency modulation
Frequency Range	576 –865 MHz*, UHF
Channel Selectable	64 channels (the number of channels may differ from country to country.)
RF Carrier Power	50 mW or less
Tone Frequency	32.768 kHz
Oscillator	PLL synthesizer
Maximum Input Level	132 dB SPL
Maximum Deviation	±40 kHz
Audio Frequency Response	100Hz – 15kHz
Dynamic Range (AF Circuit)	95dB or more (with WT-5800)
Battery	WB-2000 rechargeable battery (option) or AA alkaline dry cell battery
Battery Life	Approx. 13h (when the WB-2000 rechargeable battery is used) Approx. 10h (when the alkaline battery is used)
Indicator	Power/Battery lamps
Antenna	Built-in type
Operating Temperature	-10°C to +50°C (14°F to 122°F) (except battery)
Operating Humidity	30% to 85% RH (no condensation)
Finish	Resin, coating
Dimensions	ø50 × 229 mm (ø1.97" × 9.02")
Weight	205 g (0.45 lb) (with battery)
Accessory	Microphone holder W3/8" (with stand adapter) × 1, Screw driver × 1, Storage case × 1

Type	Frequency Range
A01	692 –722 MHz, UHF
B01, B02	722 –752 MHz, UHF
C01 – C07	794 –830 MHz, UHF
D01 – D05	830 –865 MHz, UHF
E01	668 –698 MHz, UHF
F01	636 –666 MHz, UHF
G01, G02	606 –636 MHz, UHF
H01	576 –606 MHz, UHF

WM-5225

Handheld (Speech) Microphone

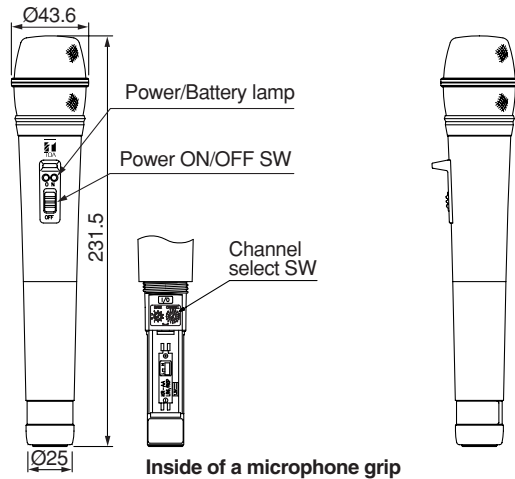

- Unidirectional electret condenser cardioid microphone element
- 64 selectable channels
- Maximum input level: 126 dB SPL
- Dynamic range: 95 dB or more
- ON/OFF switch prevents the microphone from rolling
- WB-2000 rechargeable battery or Single AA battery operation for compact and lightweight body
- Low-battery indicator (Sufficient power/Green, Low battery/Dimming green, Empty/Red)
- Built-in antenna

Microphone Element	Electret condenser microphone unit: Unidirectional
Modulation	Frequency modulation
Frequency Range	576 –865 MHz*, UHF
Channel Selectable	64 channels (the number of channels may differ from country to country.)
RF Carrier Power	50 mW or less
Tone Frequency	32.768 kHz
Oscillator	PLL synthesizer
Maximum Input Level	126 dB SPL
Maximum Deviation	±40 kHz
Audio Frequency Response	100Hz – 15kHz
Dynamic Range (AF Circuit)	95dB or more (with WT-5800)
Battery	WB-2000 rechargeable battery (option) or AA alkaline dry cell battery
Battery Life	Approx. 13h (when the WB-2000 rechargeable battery is used) Approx. 10h (when the alkaline battery is used)
Indicator	Power/Battery lamps
Antenna	Built-in type
Operating Temperature	-10°C to +50°C (14°F to 122°F) (except battery)
Operating Humidity	30% to 85% RH (no condensation)
Finish	Resin, coating
Dimensions	ø43.6 × 231.5 mm (ø1.72" × 9.11")
Weight	180 g (0.4 lb) (with battery)
Accessory	Microphone holder W3/8" (with stand adapter) × 1, Screw driver × 1, Storage case × 1

Type	Frequency Range
A01	692 –722 MHz, UHF
B01, B02	722 –752 MHz, UHF
C01 – C07	794 –830 MHz, UHF
D01 – D05	830 –865 MHz, UHF
E01	668 –698 MHz, UHF
F01	636 –666 MHz, UHF
G01, G02	606 –636 MHz, UHF
H01	576 –606 MHz, UHF

WM-4300

Wireless (Lavalier) Microphone

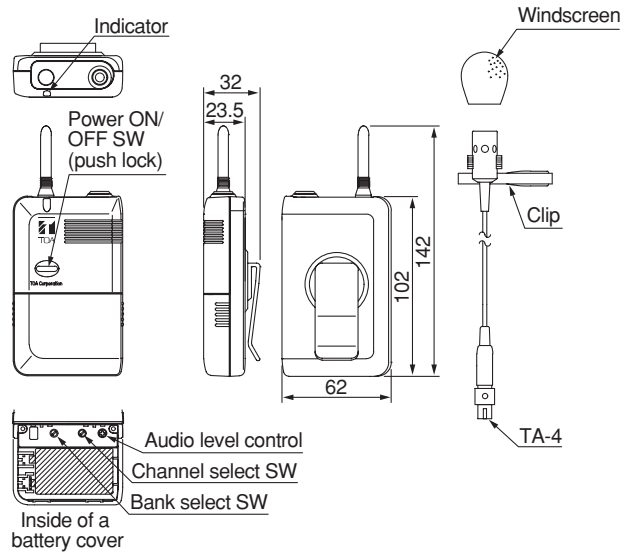

- Electret condenser cardioid microphone element for speech use
- 64 selectable channels
- Input sensitivity control included
- Maximum input level: 120 dB SPL
- Built-in circuitry minimizes ambient noise effects.
- Belt clip rotatable 360 degrees
- Highly reliable TA-4 (XLR-type) mini-cannon microphone plug
- LED-low battery indicator (Sufficient power/Orange, Low battery/Flashing orange)

Transmitter unit	
Frequency Range	692 –865 MHz*, UHF
Channel Selectable	64 channels (the number of channels may differ from country to country.)
RF Carrier Power	Under 50 mW
Tone Frequency	32.768 kHz
Oscillator	PLL synthesizer
Maximum Input Level	120 dB SPL
Battery	6LR61 (9 V × 1)
Battery Life	Over 10 hours (alkaline)
Indicator	Power/Battery indicator (common use)
Antenna	1/4λ herical antenna
Operating Temperature	-10°C to +50°C (14°F to 122°F)
Finish	Resin, coating
Dimensions	62 (W) × 142 (H) × 32 (D) mm (2.44" × 5.59" × 1.26")
Weight	135 g (0.30 lb) (with battery)
Accessory	Screw driver × 1, Storage case × 1
Microphone unit	
Microphone	Electret condenser microphone, cardioid
Power Requirement	DC (supplied from lavalier pack)
Cable Length	1.3 m (4.27 ft)
Connector	TA-4 (XLR type)

Type	Frequency Range
A01	692 –722 MHz, UHF
B01, B02	722 –752 MHz, UHF
C01 – C07	794 –830 MHz, UHF
D01 – D05	830 –865 MHz, UHF

WM-5325

Wireless Transmitter

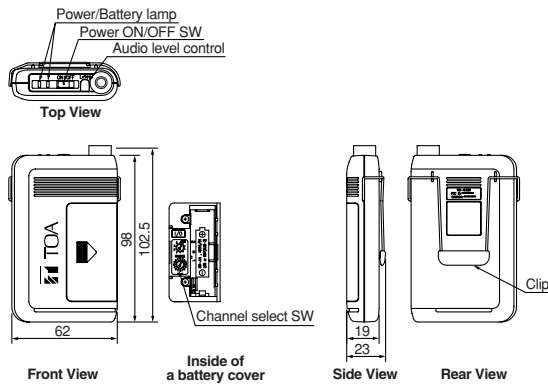

- 64 selectable channels
- Maximum input level: -14 dB to -29 dB*
- WB-2000-2 rechargeable battery or Single AA battery operation for compact and lightweight body
- Low-battery indicator (Sufficient power/Green, Low battery/ Dimming green, Empty/Red)
- Built-in antenna

Modulation	Frequency modulation
Frequency Range	576 – 865 MHz*, UHF
Channel Selectable	64 channels (the number of channels may differ from country to country.)
RF Carrier Power	50 mW or less
Tone Frequency	32.768 kHz
Oscillator	PLL synthesizer
Maximum Input Level	-14dB to -29dB* ¹ (Audio level control: Min. to Max.)
Maximum Deviation	±40 kHz
Audio Frequency Response	100Hz – 15kHz
Battery	WB-2000 rechargeable battery (option) or LR6/AA alkaline dry cell battery
Battery Life	Approx. 13h (when the WB-2000 rechargeable battery is Used) Approx. 10h (when the alkaline battery is used)
Indicator	Power/Battery lamps
Antenna	Built-in type
Connector	ø3.5mm (ø0.14") mini plug
Operating Temperature	-10°C to +50°C (14°F to 122°F) (except battery)
Operating Humidity	30% to 85% RH (no condensation)
Finish	Resin, coating
Dimensions	62 (W) × 102.5 (H) × 23 (D) mm (2.44" × 4.04" × 0.91")
Weight	90 g (0.2 lb) (with battery)
Accessory	Screw driver × 1, Storage case × 1, Neck strap × 1
Option	Unidirectional lavalier microphone: YP-M5300 Omnidirectional lavalier microphone: YP-M5310 Headset microphone: WH-4000A, WH-4000H

*1 0dB = 1V

Type	Frequency Range
A01	692 – 722 MHz, UHF
B01, B02	722 – 752 MHz, UHF
C01 – C07	794 – 830 MHz, UHF
D01 – D05	830 – 865 MHz, UHF
E01	668 – 698 MHz, UHF
F01	636 – 666 MHz, UHF
G01, G02	606 – 636 MHz, UHF
H01	576 – 606 MHz, UHF

WT-5100

Portable Receiver

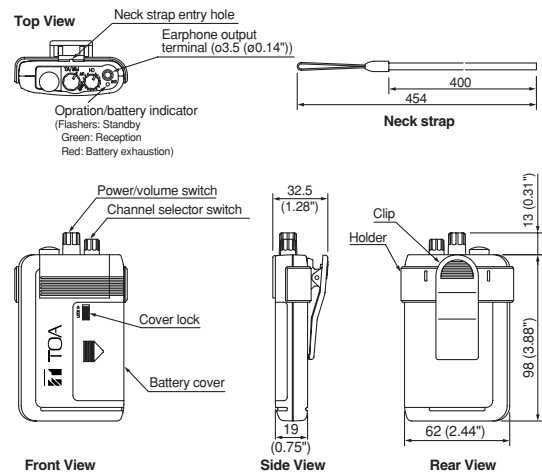

- 16 selectable channels
- Receiving System: Double super-heterodyne
- Receiving Sensitivity: Better than 60 dB
- WB-2000-2 rechargeable battery or Single AA battery operation for compact and lightweight body
- Operation/Battery indicator (Sufficient power/Green, Low battery/ Dimming green, Empty/Red)
- Built-in antenna

Power Source	1.5 V DC (Battery)
Receiving Frequencies	UHF band (16 ch)
Receiving System	Double super-heterodyne
Receiving Sensitivity	Better than 60 dB Signal to Noise ratio (20 dBμV input, ±40 kHz deviation)
Frequency Response	200 Hz – 5 kHz (Portable transmitter to Portable receiver)
DE-emphasis	50 μs
Output Level	4 mW (16Ω load, 10% distortion)
Battery	WB-2000-2 rechargeable battery (option) or LR6/AA alkaline dry cell battery
Battery Life	16 h (when the WB-2000-2 rechargeable battery is used) 18 h (when the alkaline battery is used)
Operating Temperature	-10°C to +40°C (14°F to 104°F)
Operating Humidity	30% to 85% RH (no condensation)
Finish	Resin, dark silver
Dimensions	62 (W) × 163.6 (H) × 32.5 (D)mm (2.44" × 6.44" × 1.28")
Weight	125 g (0.28 lb) (battery included)
Accessory	Neck strap × 1
Option	Ni-MH battery: WB-2000-2, Assist earphone: YP-E5000

*When using on earphone not made by TOA, use the one with a ø3.5mm plug and impedance of over 16Ω.

OPTIONS

WH-4000H Headset Microphone

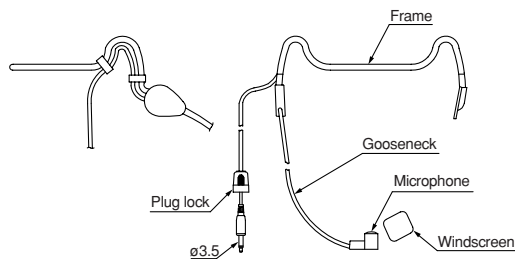

WH-4000H is headset microphone of a cardioid pick-up pattern, featuring a lightweight design.

Type	Electret condenser type
Directivity	Unidirectional
Sensitivity	-66dB ±3dB (0dB = 1V/0.1 Pa, 1kHz)
Maximum Input Level	120 dB SPL
Cable Length	1.3 m (4.27 ft)
Terminal	ø3.5mm monaural plug
Finish	Frame: Stainless, black (silicon rubber) Gooseneck: Lron, chrome-plated, black (shrink tube)
Weight	50 g (0.11 lb) (cable included)

* This product is expendable item.
No warranty is provided for any trouble except incipient failure.

WH-4000A Headset Microphone

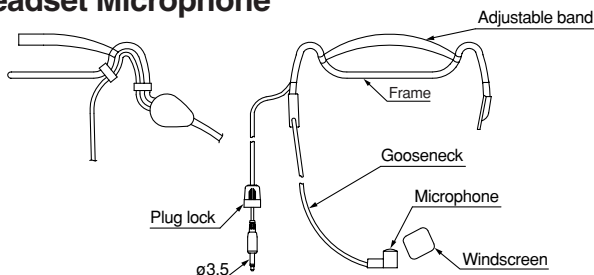

WH-4000A is headset microphone of a cardioid pick-up pattern, featuring a lightweight design.

Besides, the WH-4000A is equipped with an adjustable band to fix the headset on your head.

Type	Electret condenser type
Directivity	Unidirectional
Sensitivity	-66dB ±3dB (0dB = 1V/0.1 Pa, 1kHz)
Maximum Input Level	120 dB SPL
Cable Length	1.3 m (4.27 ft)
Terminal	ø3.5mm monaural plug
Finish	Headband: EVA, black Frame: Stainless, black (silicon rubber) Gooseneck: Lron, chrome-plated, black (shrink tube)
Weight	50 g (0.11 lb) (cable included)

* This product is expendable item.
No warranty is provided for any trouble except incipient failure.
Note: Windscreen is also available as optional parts.

YP-M5300 Unidirectional Lavalier Microphone

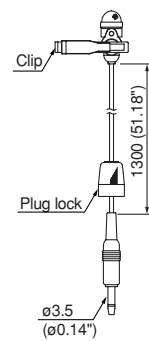

YP-M5300 is lavalier microphone. It employs an unidirectional electret condenser microphone element.

Type	Electret condenser type
Directivity	Unidirectional
Sensitivity	-63dB ±3dB (0dB = 1V/0.1 Pa, 1kHz)
Frequency Response	100 Hz - 12 kHz
Maximum Input Level	120 dB SPL
Cable Length	1.3 m (4.27 ft)
Terminal	ø3.5mm (ø0.14") mini plug
Finish	Dark black
Weight	20 g (0.71 oz) (cable included)

YP-M5310 Omnidirectional Lavalier Microphone

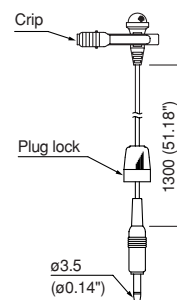

YP-M5310 is lavalier microphone. It employs an omnidirectional electret condenser microphone element.

Type	Electret condenser type
Directivity	Omnidirectional
Sensitivity	-64dB ±3dB (0dB = 1V/0.1 Pa, 1kHz)
Frequency Response	100 Hz - 15 kHz
Maximum Input Level	110 dB SPL
Cable Length	1.3 m (4.27 ft)
Terminal	ø3.5mm (ø0.14") mini plug
Finish	Dark black
Weight	20 g (0.71 oz) (cable included)

OPTIONS

YP-E5000 Assist Earphone

- * Three different sizes are more available for the suspension ring.
L: 68 x 47
M: 64 x 45
S: 60 x 43
- * The figure shows the L-size type.

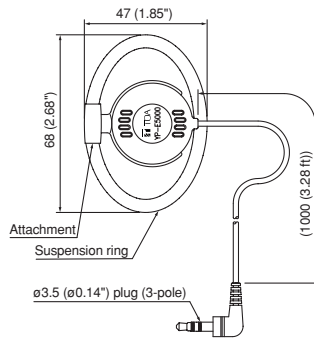

YP-E5000 is Assist Earphone is 3.5 mm in plug diameter, and 16 Ω in impedance.

Type	Dynamic type
Impedance	16 Ω
Frequency Response	300 Hz – 15 kHz
Rated Sensitivity	88dB (0dB = 2×10^{-5} Pa, 1kHz, 10 mV)
Input	Max. 50 mW
Terminal	ϕ 3.5mm (ϕ 0.14") mini plug (3-pole)
Finish	Black
Weight	17 g (0.6 oz)
Accessory	Ear-pad \times 1, Suspension ring \times 2

*When employed with the WT-5100 wireless receiver, improves audibility for hearing impaired users by raising the frequency response above the standard level.

YP-E401 Ear-suspension Earphone

- * Three different sizes are more available for the suspension ring.
L: 68 x 47
M: 64 x 45
S: 60 x 43
- * The figure shows the L-size type.

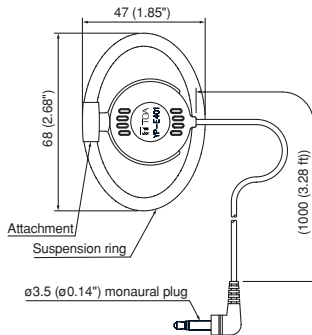

YP-E401 Ear-suspension Earphone is 3.5 mm in plug diameter, and 16 Ω in impedance.

Type	Dynamic type
Impedance	16 Ω
Frequency Response	300 Hz – 15 kHz
Rated Sensitivity	88dB (0dB = 2×10^{-5} Pa, 1kHz, 10 mV)
Input	Max. 50 mW
Terminal	ϕ 3.5mm (ϕ 0.14") monaural plug
Finish	Black
Weight	17 g (0.6 oz)
Accessory	Ear-pad \times 1, Suspension ring \times 2

WB-2000-2 Rechargeable Battery



- AA nickel-metal hydride (Ni-MH) rechargeable battery
- For the WM-5265 and WM-5225 Wireless Microphones, WM-5325 Wireless Transmitter, and WT-5100 Potable Receiver

MB-WT3 Rack Mount Bracket Kit



- For rack-mounting one WT-5800/WT-5805/WT-4820 unit.

MB-WT4 Rack Mount Bracket Kit

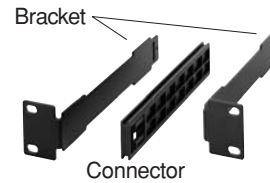

- For rack-mounting two WT-5800/WT-5805/WT-4820 units.

MB-15B Rack Mount Bracket



- For rack-mounting one WD-4800 unit.

WH-4000S Windscreen



The WH-4000S is a replacement windscreen set used exclusively for the Headset Microphone. It contains 10 pieces of windscreens.

WH-4000P Waist Pouch



The WH-4000P is a waist pouch to house a wireless microphone unit. Its elastic belt helps the pouch fit to your waist.

- Length: 800mm (31.5") (1300mm (51.18") at full extension)

YP-E401PAD01 Earphone Pad



The YP-E401PAD01 is a replacement ear pad set used exclusively for the YP-E5000 Earphone.

- It contains 100 pieces of Ear pad.

BATTERY CHARGER

Battery Chargers for the WM-5225 and WM-5265 Wireless Microphone, WM-5325 Wireless Transmitter, and WT-5100 Potable Receiver. It employs a quick charging system for nickel metal hydride (Ni-MH) batteries, allowing up to 12 (BC-5000-12) (BC-5000-6: up to 6, BC-5000-2: up to 2) wireless microphones to be fully charged within 3 hours.

BC-5000-12

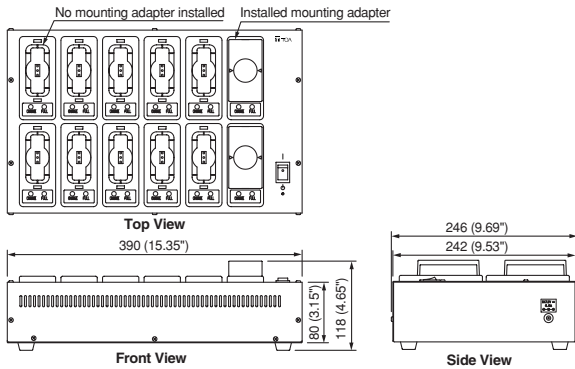

Power Source	12 V DC (optional AC adapter AD-5000-6 must be used)
Power Consumption	4.4 A
Charging Time	Max. 3 h
Number of Wireless Microphone to be Charged Simultaneously	12 pieces*
Operating Temperature	0°C to +40°C (32°F to 104°F)
Operating Humidity	30% to 85% RH (no condensation)
Finish	Case: Steel plate, black, paint Microphone receptacle section: ABS resin, black
Dimensions	390(W) × 118(H) × 246(D) mm (15.35" × 4.65" × 9.69")
Weight	3.4 kg (7.5 lb) (with mounting adapters attached)
Accessory	Mounting adapter (preinstalled on the unit) × 12
Option	Rechargeable battery: WB-2000-2 (containing 2 pieces) AC adapter: AD-5000-6

BC-5000-6

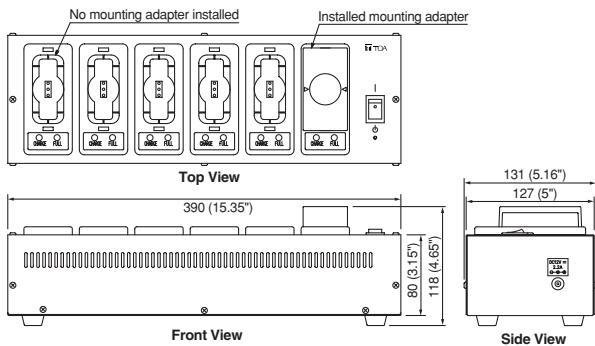

Power Source	12 V DC (optional AC adapter AD-5000-6 must be used)
Power Consumption	2.2 A
Charging Time	Max. 3 h
Number of Wireless Microphone to be Charged Simultaneously	6 pieces*
Operating Temperature	0°C to +40°C (32°F to 104°F)
Operating Humidity	30% to 85% RH (no condensation)
Finish	Case: Steel plate, black, paint Microphone receptacle section: ABS resin, black
Dimensions	390(W) × 118(H) × 131(D) mm (15.35" × 4.65" × 5.16")
Weight	2 kg (4.41 lb) (with mounting adapters attached)
Accessory	Mounting adapter (preinstalled on the unit) × 6
Option	Rechargeable battery: WB-2000-2 (containing 2 pieces) AC adapter: AD-5000-6

BC-5000-2

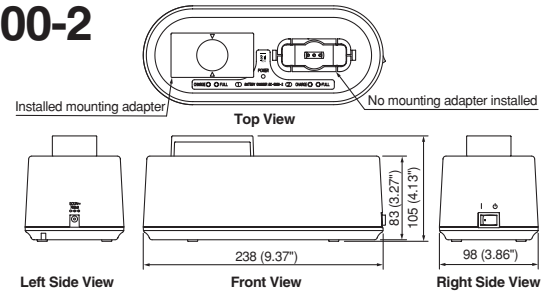

Power Source	12 V DC (optional AC adapter AD-5000-2 must be used)
Power Consumption	700 mA
Charging Time	Max. 3 h
Number of Wireless Microphone to be Charged Simultaneously	2 pieces*
Operating Temperature	0°C to +40°C (32°F to 104°F)
Operating Humidity	30% to 85% RH (no condensation)
Finish	Case: ABS resin, gray Microphone receptacle section: PPE resin, black
Dimensions	238(W) × 105(H) × 98(D) mm (9.37" × 4.13" × 3.86")
Weight	500 g (1.1 lb) (with mounting adapters attached)
Accessory	Mounting adapter (preinstalled on the unit) × 2
Option	Rechargeable battery: WB-2000-2 (containing 2 pieces) AC adapter: AD-5000-2

*Using the mounting adapter allows one each of the WM-5225, WM-5265, WM-5325, and WT-5100 to be charged in combination.

AC ADAPTER

AD-5000-6 AC Adapter for BC-5000-12 and BC-5000-6 Battery Charger. AD-5000-2 AC Adapter for BC-5000-2.

AD-5000-6

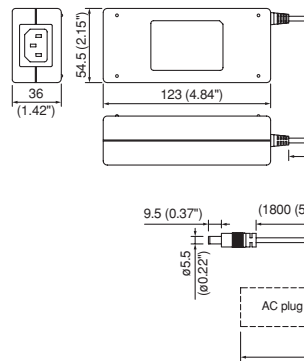

AD-5000-2

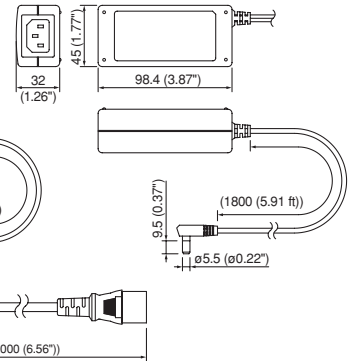

Power Source	AD-5000-6: 100 – 240 V AC, 47 – 63 Hz, 2 A, AD-5000-2: 100 – 240 V AC, 47 – 63 Hz, 1 A
Output	AD-5000-6: 12 V DC, 5 A, AD-5000-2: 12 V DC, 2 A
Ripple Voltage	120 mV p-p
Cord Length	1.8 m (5.91 ft)
Plug	Type of plug differs depending on the country where the unit is used
Operating Temperature	0°C to +40°C (32°F to 104°F)
Finish	Case: PC/ABS alloy, black
Weight	AD-5000-6: 300 g (0.66 lb), AD-5000-2: 175g (0.39 lb)
Accessory	Power cord (2m (6.56 ft)) × 1

Power cord (Accessory)

Version	AS	CN	ER	UK	US
AC Plug					

WT-5800

Wireless Tuner

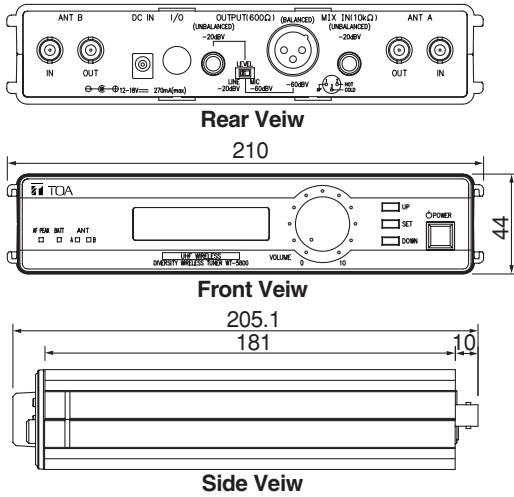

- Phase Locked Loop (PLL) synthesis operation
- 64 selectable channels
- True diversity technology
- Double super-heterodyne receiving system
- Two-line LCD display
- Auto mixing input function
- Squelch function (carrier, noise, tone)
- Usable frequencies scanning and vacant channel search function
- Compact half-rack size body
- 6 points audio level meter for microphone sensitivity adjustment
- Compander circuitry for minimizing ambient noise
- Antenna distribution output
- Whip antenna × 2
- Low-battery indicator (wireless microphone's battery voltage becomes low)

Power Source	AC mains (supplied AC adapter must be used)
Power Consumption	250mA (12V DC)
Receiving Frequency	576–865 MHz*, UHF
Channel Selectable	64 Selectable frequencies
Receiving System	Double Super-heterodyne
Diversity System	Space diversity (true diversity)
Mixing Output	MIC: -60dB*, 600Ω, balanced, XLR-3-31 type connector LINE: -20dB*, 600Ω, unbalanced, phone jack
Mixing Input	-20dB*, 10 kΩ, unbalanced, phone jack
Antenna Input	75Ω, BNC (phantom powering for antenna) 9V DC, 30mA (max.)
Antenna Output	75Ω, BNC (Gain 0dB)
Receiving Sensitivity	90dB or more, S/N ratio (20dBμV input, 40kHz deviation)
Squelch Sensitivity	18 – 40dBμV variable
Squelch System	Using together of noise SQ, carrier SQ and tone SQ
Tone Frequency	32.768 kHz
Indicator	Audio (6 step), RF (6 step), ANT A/B, Audio (peak), battery alarm
Channel Check	Usable frequencies scanning
S/N Ratio	110dB or more (A-weight, unbalanced output)
Harmonic Distortion	1% or less (typical)
Frequency Response	100 – 15kHz, ±3 dB
Operating Temperature	-10°C to +50°C (14°F to 122°F)
Finish	Resin, black
Dimensions	210(W) × 44(H) × 205.1(D) mm (8.27" × 1.73" × 8.07")
Weight	700 g (1.54 lb)
Accessory	AC adapter × 1, Wireless antenna × 2
Option (Mounting bracket kit)	MB-WT3 (for rack mounting one WT-5800 unit) MB-WT4 (for rack mounting two WT-5800 units)

*Refer to the WM-5270 page.

*10dB = 1 V

WT-5805

Wireless Tuner

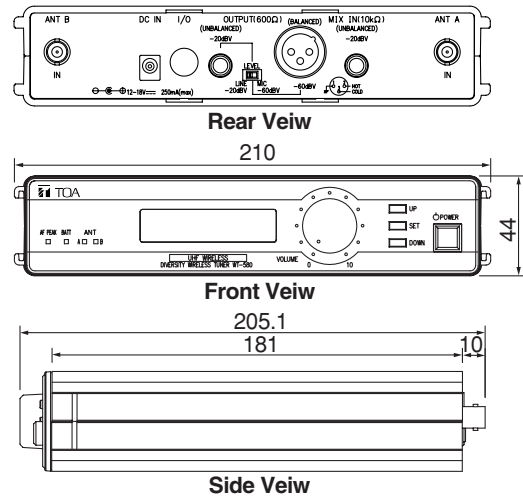

- Phase Locked Loop (PLL) synthesis operation
- 64 selectable channels
- TOA space diversity technology
- Double super-heterodyne receiving system
- Two-line LCD display
- Auto mixing input function
- Squelch function (carrier, noise, tone)
- Usable frequencies scanning and vacant channel search function
- Compact half-rack size body
- 6 points audio level meter for microphone sensitivity adjustment
- Compander circuitry for minimizing ambient noise
- Whip antenna × 2
- Low-battery indicator (wireless microphone's battery voltage becomes low)

Power Requirement	AC mains (supplied AC-DC adapter must be used)
Power Consumption	200 mA (12 V DC)
Receiving Frequency	576–865 MHz*, UHF
Channel Selectable	64 Selectable frequencies
Receiving System	Double Super-heterodyne
Diversity System	Space diversity
Mixing Output	MIC: -60 dB*, 600Ω, balanced, XLR-3-31 type connector LINE: -20 dB*, 600Ω, unbalanced, phone jack
Mixing Input	-20 dB*, 10 kΩ, unbalanced, phone jack
Antenna Input	75 Ω, BNC (phantom powering for antenna) 9 V DC, 30 mA (max.)
Receiving Sensitivity	90 dB or more, S/N ratio (20 dBμV input, 40 kHz deviation)
Squelch Sensitivity	18–40 dBμV variable
Squelch System	Using together of noise SQ, carrier SQ and tone SQ
Tone Frequency	32.768 kHz
Indicator	Audio (6 step), RF (6 step), ANT A/B, Audio (peak), battery alarm
Channel Check	Usable frequencies scanning
S/N Ratio	110dB or more (A-weight, unbalanced output)
Harmonic Distortion	1% or less (typical)
Frequency Response	100 – 15kHz, ±3 dB
Operating Temperature	-10°C to +50°C (14°F to 122°F)
Finish	Resin, black
Dimensions	210(W) × 44(H) × 205.1(D) mm (8.27" × 1.73" × 8.07")
Weight	700 g (1.54 lb)
Accessory	AC-DC adapter × 1
Option (Mounting bracket kit)	MB-WT3 (for rack mounting one WT-5805 unit) MB-WT4 (for rack mounting two WT-5805 units)

*Refer to the WM-5270 page.

*10dB = 1 V

WT-5810

Wireless Tuner

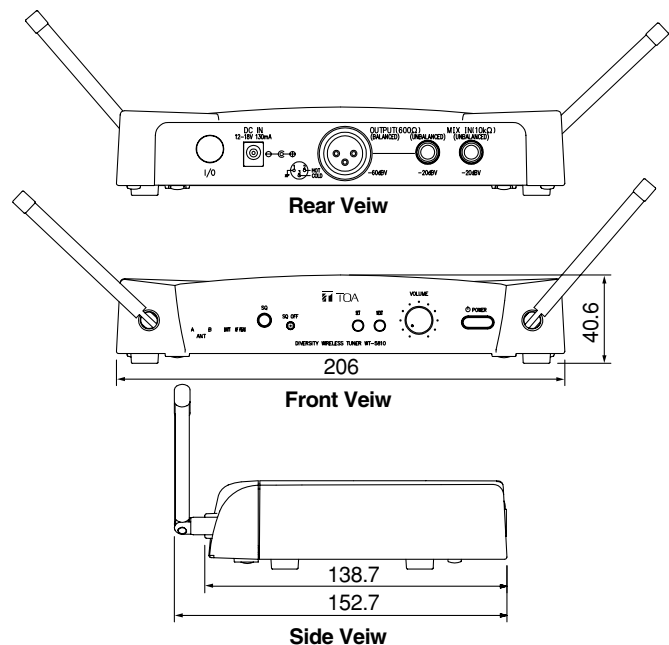

- Phase Locked Loop (PLL) synthesis operation
- 16 selectable channel frequencies
- TOA space diversity technology
- Double super-heterodyne receiving system
- Auto mixing input function
- Squelch function (carrier, noise, tone)
- Usable frequencies scanning and vacant channel search function
- Compact portable design
- Compressor circuitry for minimizing ambient noise
- Rod antenna × 2
- Balanced output (XLR connector) and phone jack output
- Low-battery indicator (wireless microphone's battery voltage becomes low)

Power Requirement	AC mains (supplied AC-DC adapter must be used)
Power Consumption	130 mA (12 V DC)
Receiving Frequency	576–865 MHz*, UHF
Channel Selectable	16 CH
Receiving System	Double Super-heterodyne
Diversity System	Space diversity
Mixing Output	MIC: -60 dB*, 600Ω, balanced, XLR-3-31 type connector LINE: -20 dB*, 600Ω, unbalanced, phone jack
Mixing Input	-20 dB*, 10 kΩ, unbalanced, phone jack
Antenna	Rod antenna
Receiving Sensitivity	Over 90 dB, S/N ratio (20 dBμV input, 40 kHz deviation)
Squelch Sensitivity	18–40 dBμV variable
Squelch System	Using together of noise SQ, carrier SQ and tone SQ
Tone Frequency	32.768 kHz
Indicator	ANT A/B, Audio (peak), battery alarm
Channel Check	Usable frequencies scanning
S/N Ratio	Over 104dB (A-weight, unbalanced output)
Harmonic Distortion	Under 1% (typical)
Frequency Response	100 – 15,000 Hz, ±3 dB
Operating Temperature	-10°C to +50°C (14°F to 122°F)
Finish	Resin, black
Dimensions	206(W) × 40.6(H) × 152.7(D) mm (8.11" × 1.60" × 6.01")
Weight	590 g (1.30 lb)
Accessory	AC-DC adapter × 1

*Refer to the WM-5270 page.

*2 0dB = 1 V

WT-4820

2-Channel Wireless Tuner

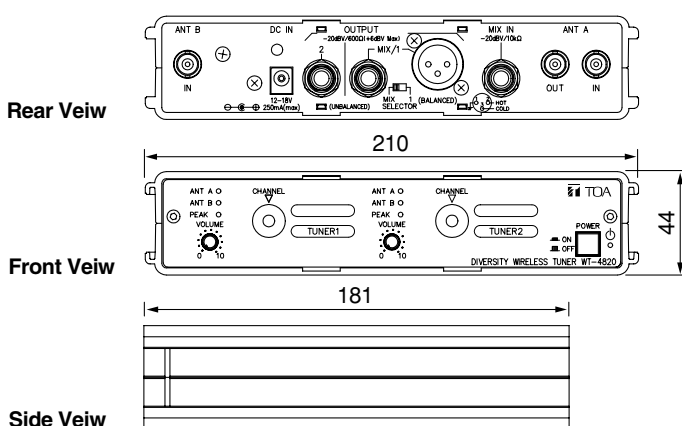

- 16 selectable channel frequencies
- Antenna cascade output function (parallel connection possible for linking two WT-4820 units)
- TOA space diversity technology
- Auto mixing input function
- Tuner unit connections accessible from the front (even if rack mounted, the front panel is easily opened)
- Mix output/tuner 1 output (selectable), tuner 2 has 2 outputs
- Whip antenna × 2
- Compact 19" rack-mount design
- External antenna input

Power Requirement	12 – 18 V DC
Power Consumption	250 mA (12 V DC when operating with two tuner modules)
Receiving Frequency	576 - 865 MHz*, UHF
Channel Selectable	16 CH
Mixing Input	-20 dB*, 10 kΩ, unbalanced, phone jack
Antenna Input	75 Ω, BNC (phantom powering for antenna) 9 V DC, 30 mA (max.)
Antenna Output	75 Ω, BNC (Gain 0dB)
Indicator	ANT A/B, Audio (peak), Power
S/N Ratio	Over 102dB (A-weight, unbalanced output)
Harmonic Distortion	Under 1%
Frequency Response	50 – 18,000 Hz, ±3 dB
Operating Temperature	-10°C to +50°C (14°F to 122°F)
Finish	Resin, black
Dimensions	210(W) × 44(H) × 181(D) mm (8.27" × 1.73" × 7.13")
Weight	770 g (1.70 lb) (without tuner module)
Accessory	Rod antenna × 2, Rubber foot × 4
Option	Rack mounting Kit: MB-WT3, MB-WT4

*1 Refer to the WM-4200 page.

*2 0dB = 1 V

WTU-4800

Wireless Tuner Unit

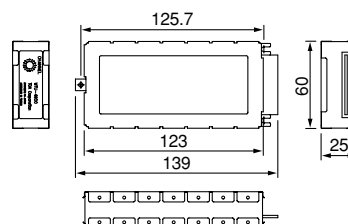

- PLL synthesis double superheterodyne diversity tuner module
- Designed for use with UHF wireless equipment
- Squelch function mutes output to reduce noise
- Includes compressor noise reduction to cut ambient RF noise
- Compact dimensions

WD-4800

Power/Antenna Distributor

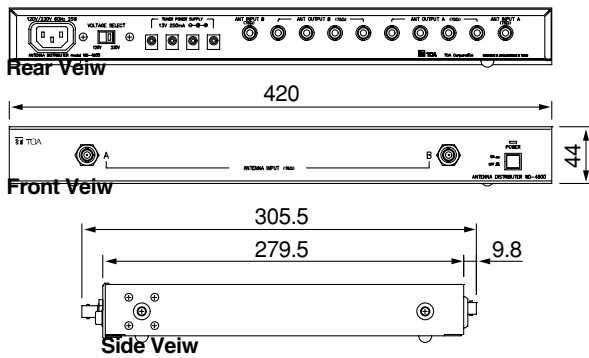

- 2 antenna inputs and 4 distributed outputs
- 2 inputs per antenna which are mixed for output (when 2 antennas are set up in a large room)
- Supplies power to the antenna and tuner
- Compact 19" rack-mount design

Power Requirement	AC mains
Power Consumption	25W
Frequency Range	VHF/UHF
Antenna Input	2 input (front x 1, rear x 1), 75 Ω, BNC (phantom powering for antenna)
Antenna Output	4 output, 75 Ω, BNC
DC Power Supply	4 output, (each output: 13V DC/250mA)
Indicator	Power
Operating Temperature	-10°C to +50°C (14°F to 122°F)
Finish	Steel, coating
Dimensions	420(W) × 44(H) × 305.5(D) mm (16.54" × 1.73" × 12.03")
Weight	3.5 kg (7.72 lb)
Accessory	DC cable × 4
Option	Rack mounting bracket: MB-15B

YW-4500

Wireless Antenna

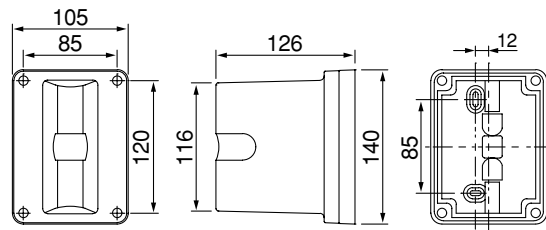

- UHF wireless dipole indoor antenna
- Wall mounted
- Power supplied by tuner (WT-5800, WT-5805, WT-4820, WD-4800) through coaxial cable
- Built-in RF signal booster
- Attenuation switch helps minimize noise and any interference.

Power Requirement	7-12 V DC (supplied from amplifier or tuner)
Current Consumption	Under 24 mA
Receiving Frequency	576-865 MHz, UHF
Dipole Ratio Relative Gain	More than 8 dB (780 MHz)
V.S.W.R	Less than 3.0
Output Impedance	75 Ω
Mounting Hole Pitch	83.5 mm (3.29") (dimensions for wiring box)
Operating Temperature	-10°C to +50°C (14°F to 122°F)
Finish	AES resin, off-white
Dimensions	105(W) × 140(H) × 126(D)mm (4.13" × 5.51" × 4.96")
Weight	270 g (0.60 lb)
Accessory	M3.5 screw for wiring box × 2, Tapping screw (M4) for wooden wall × 2, RG-6/U or RG-11/U sleeve × 1

Polar Response

Vocal microphones

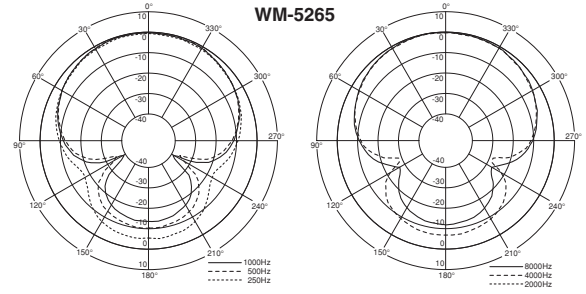
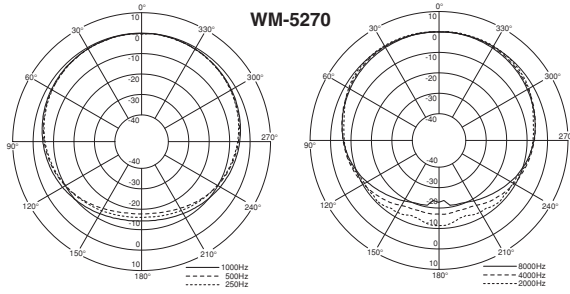

Speech microphones

